

PARTS FOR UNCOMMON ANTIQUE BRITISH VEHICLES & VINTAGE AIRCRAFT



Questions? Call 1-888-243-0440

**AC Parts**

- [Body](#)
- [Books and Manuals](#)
- [Brakes](#)
- [Clutch and Gearbox](#)
- [Cooling](#)
- [Electrical](#)
- [Engine](#)
- [Fuel and Filters](#)
- [Lamps and Lenses](#)
- [Rubber and Glass](#)
- [Upholstery and Trim](#)

[Back to Other British listing](#)



Toll Free Order Line (US and Canada) **(888) 243-0440**  
Information / International **011+ (972) 243-0440**

[Kip Motor Home](#) | [Main Menu](#) | [Berkeley](#) | [Metropolitan](#) | [English Ford](#) | [Hillman](#) | [London Taxi](#) | [Uncommon British Vehicles](#) | [Vintage Aircraft](#) |

[Backorders](#) | [Core Charges](#) | [Returns](#) | [Shipping](#) | [Warranty](#) | [Email Kip Motor](#)

Our mission is to ensure that yesterday's antique or collector vehicle can be restored, maintained and preserved for current and future generations.

© Copyright Kip Motor Company 2007-2022 | [Privacy Statement](#)  
Kip Motor Company | 2127 Crown Rd | Dallas, Texas 75229 | (972) 243-0440

[Powered by King\\_Cart\\_Services](#)

PARTS FOR UNCOMMON ANTIQUE BRITISH VEHICLES & VINTAGE AIRCRAFT



Questions? Call 1-888-243-0440



AC BOOKS AND MANUALS

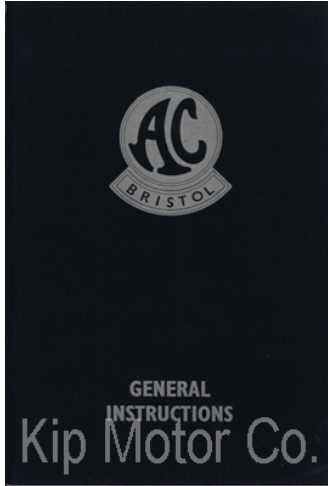

Item No	Part #	Image	Description	App	Qty Required	Price Each	Qty to Purchase	Add to Cart
	SM-31		Bristol - Shop Manual	Bristol	1	\$107.64	1	Add
<p>All publications are reproductions of the original factory publication.</p>								

[Check Out](#)

Toll Free Order Line (US and Canada) (888) 243-0440  
 Information / International 011+ (972) 243-0440

[Kip Motor Home](#) | [Main Menu](#) | [Berkeley](#) | [Metropolitan](#) | [English Ford](#) | [Hillman](#) | [London Taxi](#) | [Uncommon British Vehicles](#) | [Vintage Aircraft](#) |

[Backorders](#) | [Core Charges](#) | [Returns](#) | [Shipping](#) | [Warranty](#) | [Email Kip Motor](#)

Our mission is to ensure that yesterday's antique or collector vehicle can be restored, maintained and preserved for current and future generations.

© Copyright Kip Motor Company 2007-2022 [Privacy Statement](#)  
 Kip Motor Company | 2127 Crown Rd | Dallas, Texas 75229 | (972) 243-0440

Powered by [King Cart Services](#)

PARTS FOR UNCOMMON ANTIQUE BRITISH VEHICLES & VINTAGE AIRCRAFT



Questions? Call 1-888-243-0440



AC CLUTCH

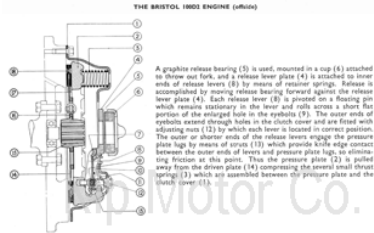
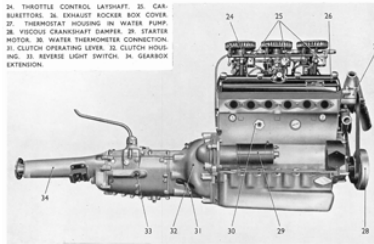

Item No	Part #	Image	Description	App	Qty Required	Price Each	Qty to Purchase	Add to Cart
	120308		Clutch Master Cylinder	Ace & Aceca Bristol	1	\$224.94	<input type="text" value="1"/>	<a href="#">Add</a>
	271512		Clutch Master Cylinder KIT	Ace & Aceca Bristol	1	\$35.61	<input type="text" value="1"/>	<a href="#">Add</a>
	512119		Slave Cylinder	Ace & Aceca Bristol	1	\$278.18	<input type="text" value="1"/>	<a href="#">Add</a>
	ACAB-SCK		Slave Cylinder KIT	Ace & Aceca Bristol	1	\$15.64	<input type="text" value="1"/>	<a href="#">Add</a>
	9163200		Clutch Hydraulic Hose	Ace & Aceca Bristol	1	\$64.23	<input type="text" value="1"/>	<a href="#">Add</a>
	ACAB-C		Clutch Cover (X)	Ace & Aceca Bristol	1	\$229.63	<input type="text" value="1"/>	<a href="#">Add</a>
	7H3215		Clutch Plate (X50) Price includes a \$50 core charge that is refunded once we receive your rebuildable core.	Ace & Aceca Bristol	1	\$206.75	<input type="text" value="1"/>	<a href="#">Add</a>
	7H3141		Clutch Release Bearing	Ace & Aceca Bristol	1	\$46.59	<input type="text" value="1"/>	<a href="#">Add</a>
	7H4739		Brake/Clutch Fluid CASTROL DOT 4	QT	1	\$20.99	<input type="text" value="1"/>	<a href="#">Add</a>

**TECH NOTE: Use only CASTROL DOT 4 Brake Fluid** The seals and hoses in your brake and clutch system are made from natural rubber which is only compatible with vegetable based brake fluid. The only vegetable based brake fluid generally available in the US is Castrol Brake Fluid DOT 4. Use of improper fluids or mixing of fluids can lead to complete failure of brake and clutch hydraulics. On cars not used for daily transportation, brake and clutch systems should be exercised on a regular schedule.

(U) indicates used parts.  
(X) indicates rebuilt items sold exchange only. The core charge is credited once we receive your rebuildable core. Reservoirs, servo units and hardware also available. Please call (888) 243-0440.

[Check Out](#)

Toll Free Order Line (US and Canada) **(888) 243-0440**  
Information / International **011+ (972) 243-0440**

[Kip Motor Home](#) | [Main Menu](#) | [Berkeley](#) | [Metropolitan](#) | [English Ford](#) | [Hillman](#) | [London Taxi](#) | [Uncommon British Vehicles](#) | [Vintage Aircraft](#) |

[Backorders](#) | [Core Charges](#) | [Returns](#) | [Shipping](#) | [Warranty](#) | [Email Kip Motor](#)

Our mission is to ensure that yesterday's antique or collector vehicle can be restored, maintained and preserved for current and future generations.

© Copyright Kip Motor Company 2007-2022 [Privacy Statement](#)  
Kip Motor Company | 2127 Crown Rd | Dallas, Texas 75229 | (972) 243-0440

Powered by [King Cart Services](#)

PARTS FOR UNCOMMON ANTIQUE BRITISH VEHICLES & VINTAGE AIRCRAFT







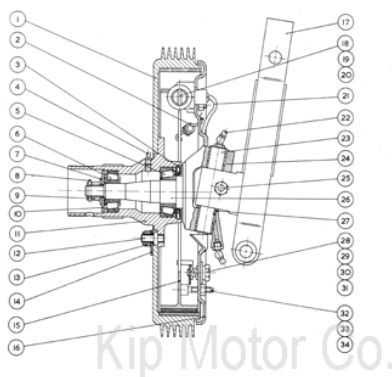

Questions? Call 1-888-243-0440



AC BRAKES



Item No	Part #	Image	Description	App	Qty Required	Price Each	Qty to Purchase	Add to Cart
	ACAB-BMC		Brake master cylinder	Ace & Aceca Bristol	1	\$155.63	<input type="text" value="1"/>	<a href="#">Add</a>
	ACAB-FWCL		Front wheel cylinder (2 per wheel) LH	Ace & Aceca Bristol	4	\$148.08	<input type="text" value="4"/>	<a href="#">Add</a>
	ACAB-FWC		Front wheel cylinder (2 per wheel) RH	Ace & Aceca Bristol	4	\$148.08	<input type="text" value="4"/>	<a href="#">Add</a>
	P743		Front wheel cylinder kit	Ace & Aceca Bristol	4	\$52.91	<input type="text" value="4"/>	<a href="#">Add</a>
	7H4465/4		Rear wheel cylinder	Ace & Aceca Bristol	2	\$210.30	<input type="text" value="2"/>	<a href="#">Add</a>
	P477		Rear wheel cylinder KIT	Ace & Aceca Bristol	2	\$42.26	<input type="text" value="2"/>	<a href="#">Add</a>
	ACAB-FS		Front brake shoes (set of 4) (X)	Ace & Aceca Bristol	1	\$151.73	<input type="text" value="1"/>	<a href="#">Add</a>
	ACAB-RS		Rear brake shoes (set of 4) (X)	Ace & Aceca Bristol	1	\$151.73	<input type="text" value="1"/>	<a href="#">Add</a>
	243191		Front brake hydraulic hose	Ace & Aceca Bristol	2	\$65.56	<input type="text" value="2"/>	<a href="#">Add</a>
	P.49042		Rear brake hydraulic hose	Ace & Aceca Bristol	1	\$64.23	<input type="text" value="1"/>	<a href="#">Add</a>
	7H4739		Brake/Clutch Fluid CASTROL DOT 4	QT	1	\$20.99	<input type="text" value="1"/>	<a href="#">Add</a>

**TECH NOTE: Use only CASTROL DOT 4 Brake Fluid** The seals and hoses in your brake and clutch system are made from natural rubber which is only compatible with vegetable based brake fluid. The only vegetable based brake fluid generally available in the US is Castrol Brake Fluid DOT 4. Use of improper fluids or mixing of fluids can lead to complete failure of brake and clutch hydraulics. On cars not used for daily transportation, brake and clutch systems should be exercised on a regular schedule.

(U) indicates used parts.

(X) indicates rebuilt items sold exchange only. The core charge is credited once we receive your *rebuildable* core. Reservoirs, servo units and hardware also available. Please call (888) 243-0440.

**Check Out**

Toll Free Order Line (US and Canada) **(888) 243-0440**  
Information / International **011+ (972) 243-0440**

[Kip Motor Home](#) | [Main Menu](#) | [Berkeley](#) | [Metropolitan](#) | [English Ford](#) | [Hillman](#) | [London Taxi](#) | [Uncommon British Vehicles](#) | [Vintage Aircraft](#) |

[Backorders](#) | [Core Charges](#) | [Returns](#) | [Shipping](#) | [Warranty](#) | [Email Kip Motor](#)

Our mission is to ensure that yesterday's antique or collector vehicle can be restored, maintained and preserved for current and future generations.

© Copyright Kip Motor Company 2007-2022 [Privacy Statement](#)  
Kip Motor Company | 2127 Crown Rd | Dallas, Texas 75229 | (972) 243-0440

[Powered by King Cart Services](#)